

INPUT GAIN (dB)

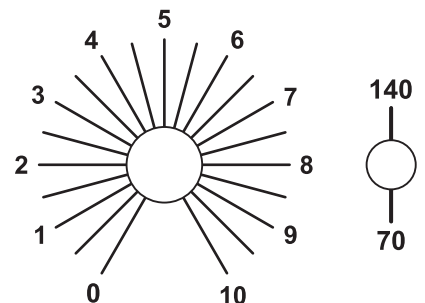

BASS BOOST f (Hz)

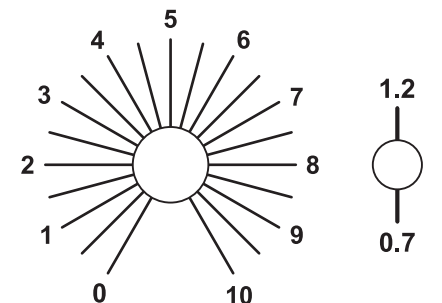

TOP SHELF f (kHz)

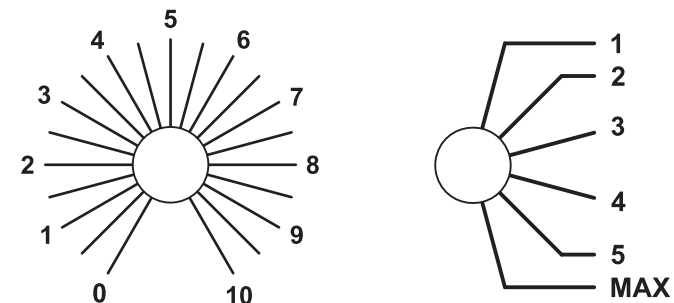

AIR ATTITUDE

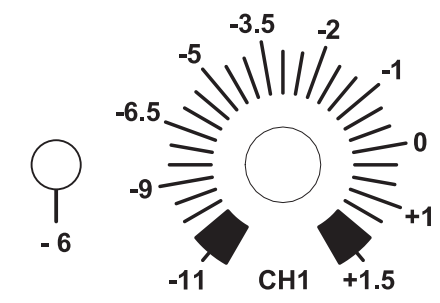

O/P TRIM (dB) CH1



BYPASS

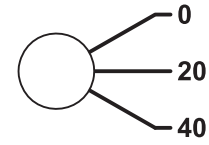

HPF (Hz)

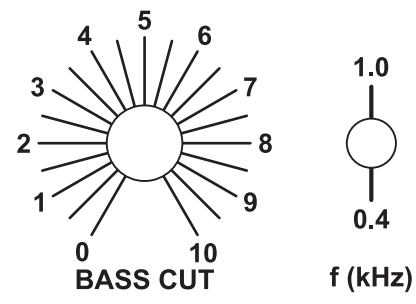

BASS CUT f (kHz)

THERMIONIC CULTURE LTD.
The Kite
 Stereo Equaliser with Attitude

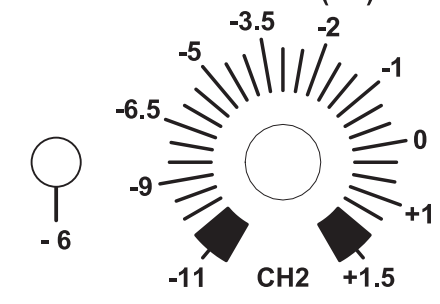

O/P TRIM (dB) CH2

